

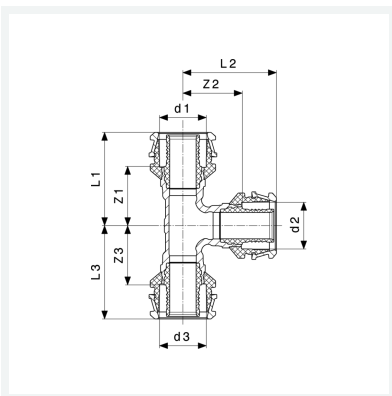

**Raxofix-T-Stück
mit SC-Contur**
- Pressanschlüsse
Modell 5318

Artikel 647 445



Eigenschaften

Rohraußendurchmesser 1	d1	32
Rohraußendurchmesser 2	d2	20
Rohraußendurchmesser 3	d3	32
Z-Maß 1	Z1	30 mm
Z-Maß 2	Z2	30 mm
Z-Maß 3	Z3	30 mm
Länge 1	L1	50 mm
Länge 2	L2	45 mm
Länge 3	L3	50 mm
Gewicht	246 g	



**Raxofix-T-Stück
mit SC-Contur
Modell 5318
Artikel 647 445**

Eigenschaften

Volumen	497,28 cm ³
Werkstoff	Siliziumbronze