



Sanpress Inox G XL-Bogen 45° mit SC-Contur

- Einsteckende, Pressanschluss

Ausstattung

Dichtelement HNBR, Schneidring, Trennring

Modell 0226.1XL

Artikel 578 299

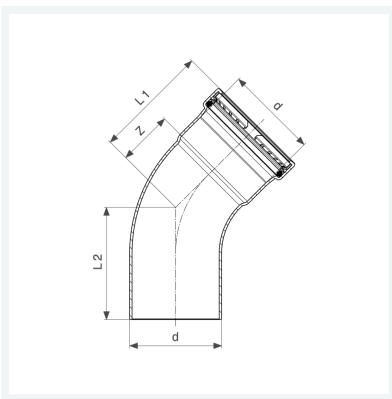

Eigenschaften

Rohraußendurchmesser	d	64,0
Z-Maß	Z	39 mm
Länge 1	L1	82 mm
Länge 2	L2	82 mm
Gewicht	600 g	
Volumen	1554 cm ³	
Werkstoff	Stahl nichtrostend	