

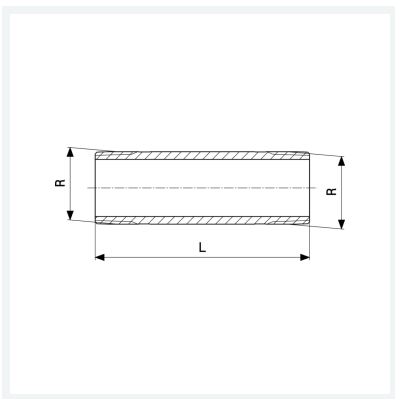

Langnippel
- R-Gewinde
Modell 3530

Artikel 318 437



Eigenschaften

Länge	L	180
Außengewinde kegelig	R	¾
Länge	L	180 mm
Gewicht	385,06 g	
Volumen	310,8 cm ³	
Werkstoff	Rotguss oder Siliziumbronze	