

ASP534 LED

Mastleuchten

1/15

we-ef

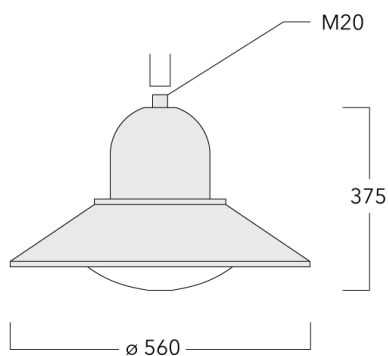

Beschreibung

IP55, SKI, IK10. Korrosionsbeständiger Aluminiumguss. PCS beschichtete Edelstahlschrauben. 5CE Korrosionsschutz. Silikondichtung. Polycarbonat Abdeckung. Eingebaute elektronische Betriebsgeräte, thermisch getrennt. CAD-optimierte OLC® One LED Concept Technik zur Lichtlenkung und Entblendung. Eingebaute LED Platine. Variante mit 2200 K erhältlich, bei Bestellung bitte angeben. Ausleger sind separat zu bestellen.

ASP534 LED





Mastleuchten

2/15

we-ef

Spezifikationen

Materialbeschreibung

Gehäuse:	Korrosionsbeständiges Aluminium
Abdeckung:	Polycarbonat Abdeckung
Farben:	 RAL9004 Signalschwarz  RAL9006 Weißaluminium  RAL9007 Graualuminium  RAL7016 Anthrazitgrau  RAL9016 Verkehrsweiß
Dichtung:	Silikondichtung
Schrauben:	PCS beschichtete Edelstahlschrauben
Schutzart:	IP55
Schlagfestigkeit:	IK10
Korrosionsschutz:	5CE
Überspannungsschutz:	6/6 kV (optional SP10)
Windangriffsfläche:	0.0898 m ²

Elektrische Beschreibung

Netz:	220-240V / 50-60 Hz
Leistungsfaktor:	> 0,9
Vorschaltgerät:	Eingebaute elektronische Betriebsgeräte

Lebensdauer

Ta=25° L90B10 > 90000h

ASP534 LED



Mastleuchten

3/15

we-ef

Auswahl

Lichtverteilungen

	asymmetrisch seitlich [S65]
	asymmetrisch vorwärts, breitstrahlend [R65]



Nominal Lichtstrom

3024
3480
3720
3960
4200
5592
5903
6960
7025
7190





Nominal Watt

24
48

Farbtemperaturen

	2700 K
	3000 K
	4000 K

Farben

	RAL9004 Signalschwarz
	RAL9006 Weißaluminium
	RAL9007 Graualuminium
	RAL7016 Anthrazitgrau
	RAL9016 Verkehrsweiß

Konfigurationen

Lichtverteilungen



asymmetrisch seitlich [S65]

Artikelnummer	Lichtquelle	Bemessungslichtstrom	Bemessungsleistung	CRI	Gewicht	Link
127-1421	LED-12/24W / 700 mA - 2700 K	2378.6	28	80	11,40	↗
127-1234	LED-12/24W / 700 mA - 3000 K	2510.4	28	80	11,40	↗
127-1235	LED-12/24W / 700 mA - 4000 K	2510.4	28	80	11,40	↗
127-1422	LED-24/48W / 700 mA - 2700 K	4757.2	55	80	11,40	↗
127-1230	LED-24/48W / 700 mA - 3000 K	5021.7	55	80	11,40	↗
127-1231	LED-24/48W / 700 mA - 4000 K	5021.7	55	80	11,40	↗
127-1422-70	LED-24/48W / 700 mA - 2700 K	6051.1	55	70	11,40	↗
127-1230-70	LED-24/48W / 700 mA - 3000 K	5975.9	55	70	11,40	↗
127-1235-70	LED-12/24W / 700 mA - 4000 K	3057.7	28	70	11,40	↗
127-1421-70	LED-12/24W / 700 mA - 2700 K	3025.6	28	70	11,40	↗
127-1234-70	LED-12/24W / 700 mA - 3000 K	2987.4	28	70	11,40	↗
127-1231-70	LED-24/48W / 700 mA - 4000 K	6116.5	55	70	11,40	↗



asymmetrisch vorwärts, breitstrahlend [R65]

127-1423	LED-12/24W / 700 mA - 2700 K	2168.9	28	80	11,40	↗
127-1236	LED-12/24W / 700 mA - 3000 K	2289.1	28	80	11,40	↗
127-1237	LED-12/24W / 700 mA - 4000 K	2289.1	28	80	11,40	↗
127-1424	LED-24/48W / 700 mA - 2700 K	4337.7	55	80	11,40	↗
127-1232	LED-24/48W / 700 mA - 3000 K	4578.9	55	80	11,40	↗
127-1233	LED-24/48W / 700 mA - 4000 K	4578.9	55	80	11,40	↗
127-1423-70	LED-12/24W / 700 mA - 2700 K	2758.8	28	70	11,40	↗
127-1236-70	LED-12/24W / 700 mA - 3000 K	2724	28	70	11,40	↗
127-1237-70	LED-12/24W / 700 mA - 4000 K	2788.1	28	70	11,40	↗
127-1424-70	LED-24/48W / 700 mA - 2700 K	5517.6	55	70	11,40	↗
127-1232-70	LED-24/48W / 700 mA - 3000 K	5448.9	55	70	11,40	↗
127-1233-70	LED-24/48W / 700 mA - 4000 K	5577.2	55	70	11,40	↗

ASP534 LED

Mastleuchten





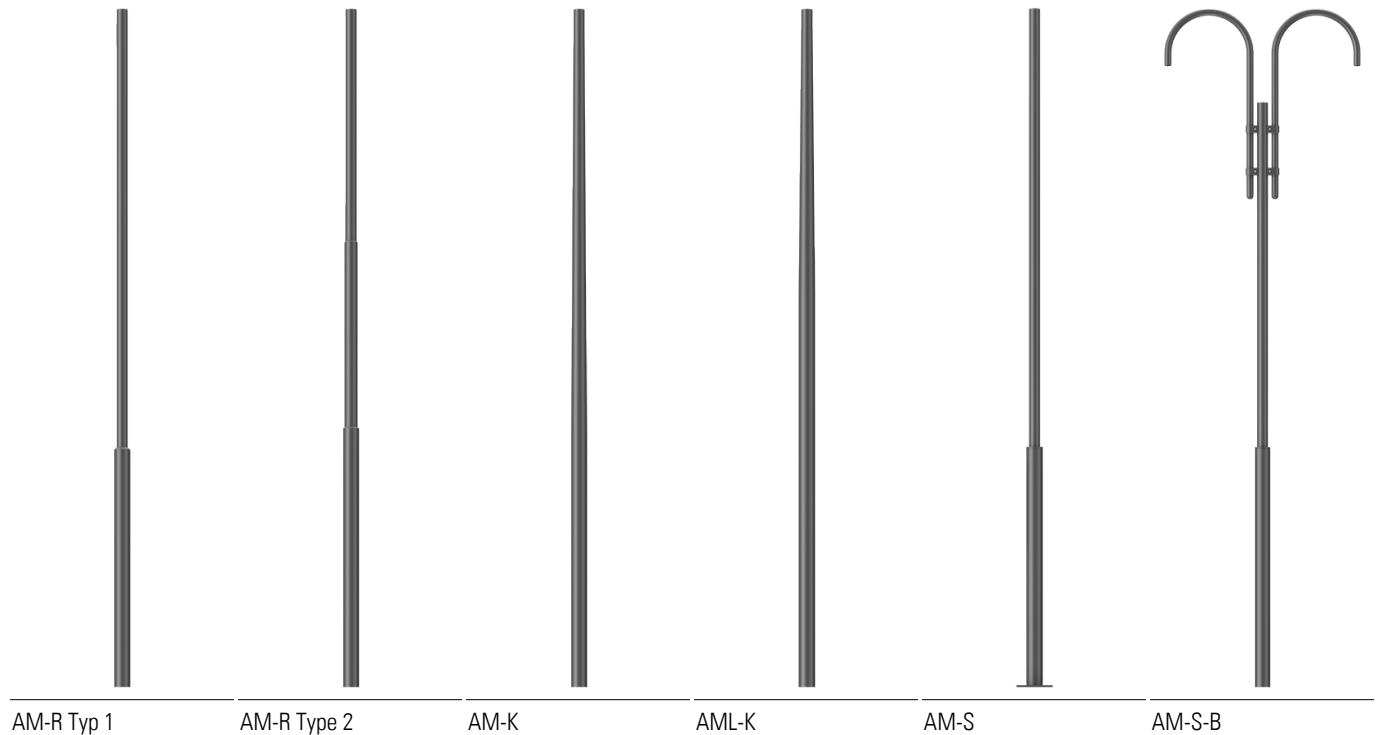

5/15

we-ef

Verfügbare Masten



Zugehörige Produkte / ASP500

Produktfamilie	Maße	Wattage	Nominal Lichtstrom	Links	
				Links	Datenblatt downloaden
ASP534 LED	 375 x 560	24 -48 W	3024 -7190		
ASP544 LED	 430 x 700	48 -72 W	5592 -10784		

ASP534 LED

Mastleuchten

6/15

we-ef

Montagezubehör

Wand- und Mastausleger BA

	C1	H1	H2	M1	Gewicht (kg)
■ 300-0152 BA0-420 Wandausleger, einfach	460	1000	132	9	2

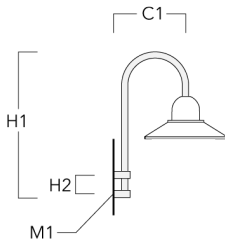

	C1	D x L	H1	Gewicht (kg)
■ 300-0099 BA1-420 Mastausleger, einfach	420	76 x 80	1000	4

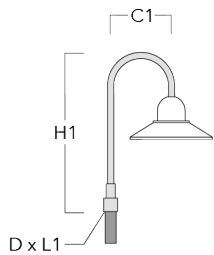

ASP534 LED

Mastleuchten

we-ef

7/15

	C1	D x L	H1	Gewicht (kg)
■ 300-0104 BA2-420 Mastausleger, zweifach	500	76 x 80	1000	8

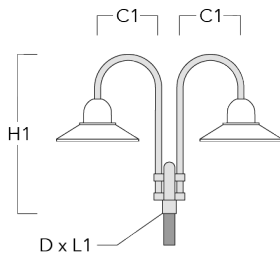

	C1	D x L	H1	Gewicht (kg)
■ 300-0109 BA3-420 Mastausleger, dreifach	500	76 x 80	1000	10

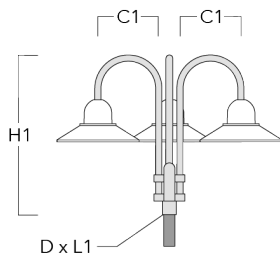

ASP534 LED

Mastleuchten

8/15

we-ef

Wand- und Mastausleger BC

	C1	H1	H2	M1	Gewicht (kg)
■ 300-0808 BC0-420 Wandausleger, einfach	460	1230	300	8	2,30

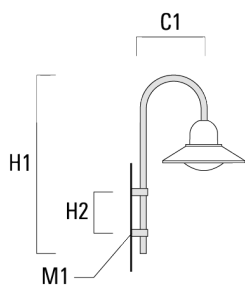

	C1	H1	H2	M1	Gewicht (kg)
■ 300-0768 BC1-420 Mastausleger, einfach	500	1230	300	8	2,30

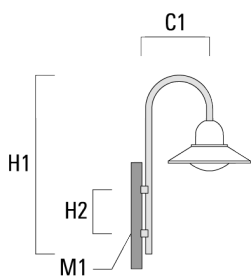

ASP534 LED

Mastleuchten

9/15

we-ef

	C1	H1	H2	M1	Gewicht (kg)
■ 300-0767 BC2-420 Mastausleger, zweifach	500	1230	300	8	4,60

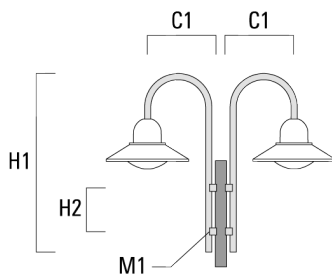

Wand- und Mastausleger DA

	C1	C2	H1	Gewicht (kg)
■ 300-0146 DA0-500 Wandausleger, einfach	510	70	650	5,70

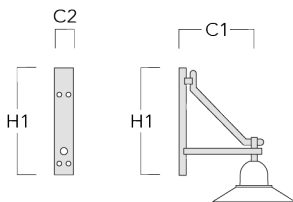

ASP534 LED

Mastleuchten

we-ef

10/15

	C1	D x L	H1	Gewicht (kg)
■ 300-0138 DA1-500 Mastausleger, einfach	510	76 x 80	700	5,70

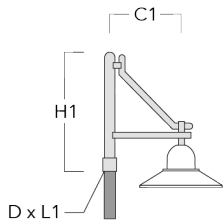

	C1	D x L	H1	Gewicht (kg)
■ 300-0141 DA2-500 Mastausleger, zweifach	510	76 x 80	700	8,30

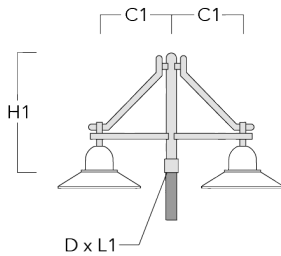

ASP534 LED

Mastleuchten

we-ef

11/15

	C1	D x L	H1	Gewicht (kg)
■ 300-0144 DA3-500 Mastausleger, dreifach	510	76 x 80	700	10,90

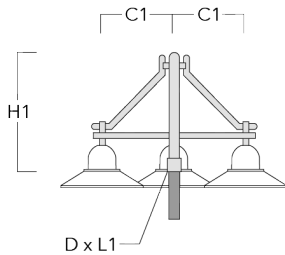

Wand- und Mastausleger DB

	C1	C2	H1	Gewicht (kg)
■ 300-0169 DB0-500 Wandausleger, einfach	510	70	650	5,50

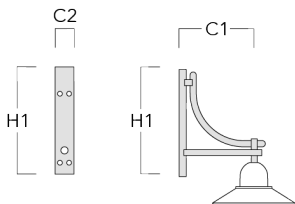

ASP534 LED

Mastleuchten

we-ef

12/15

	C1	D x L	H1	Gewicht (kg)
■ 300-0190 DB1-500 Mastausleger, einfach	510	76 x 80	700	5,50

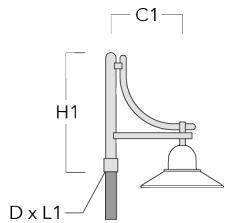

	C1	D x L	H1	Gewicht (kg)
■ 300-0191 DB2-500 Mastausleger, zweifach	510	76 x 80	700	7,90

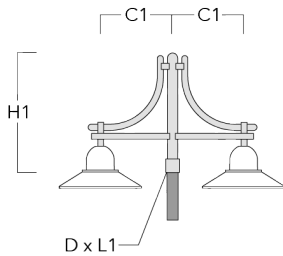

ASP534 LED

Mastleuchten

13/15

we-ef

	C1	D x L	H1	Gewicht (kg)
■ 300-0192 DB3-500 Mastausleger, dreifach	510	76 x 80	700	10,30

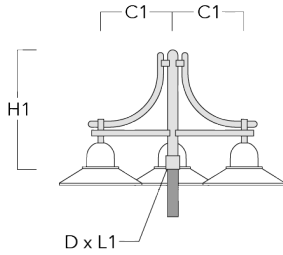

Wand- und Mastausleger DS

	C1	C2	H1	Gewicht (kg)
■ 300-0064 DS0-500 Wandausleger, einfach	510	70	650	2,50

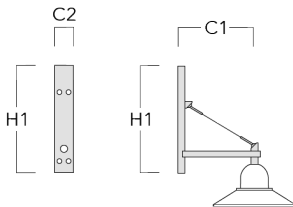

ASP534 LED

Mastleuchten

we-ef

14/15

	C1	D x L	H1	Gewicht (kg)
■ 300-0063 DS1-500 Mastausleger, einfach	510	76 x 80	725	3,90

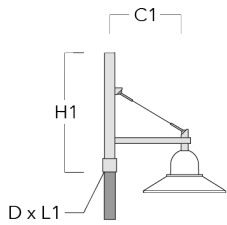

	C1	D x L	H1	Gewicht (kg)
■ 300-0066 DS2-500 Mastausleger, zweifach	510	76 x 80	725	5,30

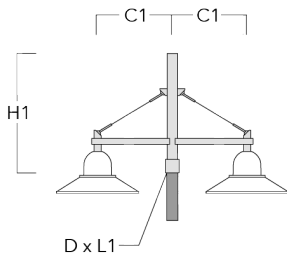

ASP534 LED

Mastleuchten

we-ef

15/15

	C1	D x L	H1	Gewicht (kg)
■ 300-0069 DS3-500 Mastausleger, dreifach	510	76 x 80	725	6,70

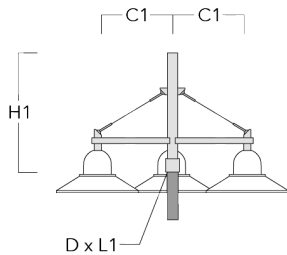

Optisches Zubehör

Blendschutz

■ **430-0024** LS360-75

■ **430-0029** LS180

■ **430-0038** LS180-[A60]

Elektrisches Zubehör

Überspannungsschutz SP10

■ **430-0020** SP10 Integral

Steuerung

DALI interface

■ **430-0013** DALI interface

Eco Step Dim® Advanced LED

■ **430-0002** Eco Step Dim® Advanced LED

Eco Step Dim® Basic LED

■ **430-0001** Eco Step Dim® Basic LED