

DX³ STOP ARC 10000 A

Cat. N°(s): 4 159 55 / 56 / 57 / 58 / 64 / 65 / 66 / 67 / 68

Phase + Neutral, neutral on right side



CONTENTS	PAGE
1. Description, use.....	1
2. Range	1
3. Overall dimensions	1
4. Preparation – Connection	1
5. General characteristics.....	3
6. Compliance and approvals	14
7. Curves.....	15
8. Auxiliaries and accessories	22
9. Safety.....	22

1. DESCRIPTION - USE

Arc fault detection device integrated with Residual Current Circuit Breaker with Overload Protection (RCBO) with contact position indication for control, protection against short-circuits and overloads, and isolation of electrical circuits, protecting people from direct and indirect contact and protecting installations from insulation faults. Reduction of the risk of fire ignition in the electrical circuit.

Symbol:

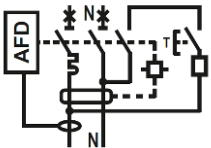

Technology:

- . Limiting device
- . The Neutral contact closes before and opens after the Phase contact
- . The phase pole provides protection and isolation for the phase circuit
- . The neutral pole provides isolation for the neutral circuit

2. RANGE

Polarity:

- . 2 poles including 1 protected pole and 1 neutral pole

Width:

- . 3 modules (54 mm)

Rated current In:

- . 6 / 10 / 13 / 16 / 20 A, C curve
- . 6 / 10 / 13 / 16 A, B curve

Magnetic tripping curve:

- . C curve (between 5 In and 10 In)
- . B curve (between 3 In and 5 In)

Type:

- . A (residual currents with a DC component)

Sensitivity:

- . 30 mA

2. RANGE (continued)

Rated voltage and frequency:

- . 230 V ~, 50 Hz with standard tolerances

Breaking capacity:

- . Icn = 10000 A in accordance with standard EN/IEC 61009-1

3. OVERALL DIMENSIONS

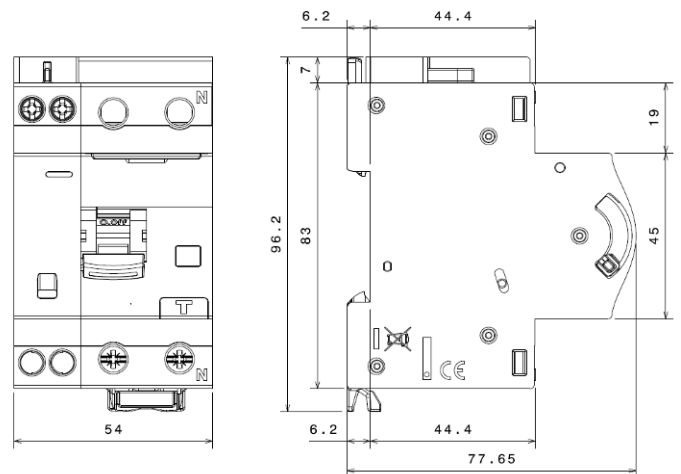

4. PREPARATION - CONNECTION

Mounting:

- . On symmetrical rail EN 60715 or DIN 35 rail

Operating positions:

Vertical horizontal upside down Flat

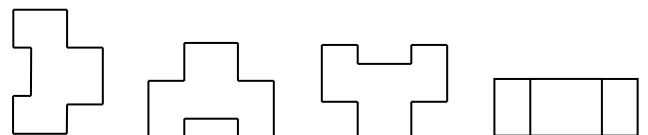

Trip indication on residual current fault:

- . Yellow indicator on the front

Power supply:

- . From the bottom

Phase + Neutral, neutral on right side

4. POSITIONING - CONNECTION (continued)

Connection:

- Terminals protected against direct finger contact IP20 when wired device
- Cage terminals, with release and captive screws
- Terminals fitted with shutters preventing a cable being placed under the terminal, with the terminal partly open or closed
- Alignment and spacing of the terminals permitting shutters with the other products via fork supply busbars
- Terminal depth: 12 mm at the top and 13 mm at the bottom
- Screw head: mixed head, slotted head and Pozidriv no. 2
- Tightening torques:
 - Recommended: 2.5 Nm
 - Min.: 2 Nm
 - Max.: 2.8 Nm

Conductor type:

- Copper cable at the top and bottom of the product
- Cable cross-section

	Without ferrule	With ferrule
Rigid cable	1 x 1.5 to 16 mm ² 2 x 1.5 to 6 mm ²	-
Flexible cable	1 x 1.5 to 10 mm ² 2 x 1.5 to 4 mm ²	1 x 1.5 to 10 mm ²

Required tools:

- For the terminals:
 - 5.5 mm blade screwdriver
 - Pozidriv n°2 screwdriver
- For the latching:
 - 5.5 mm blade screwdriver recommended / 6 mm maximum
 - Pozidriv n°2 screwdriver

Manual actuation of the DX³ STOP ARC:

- Ergonomic 2-position handle
- "O-OFF" : device open
- "I-ON" : device closed

Contact status display:

- By marking of the handle
- "O-OFF" in white on a green background = contacts open
- "I-ON" in white on a red background = contacts closed





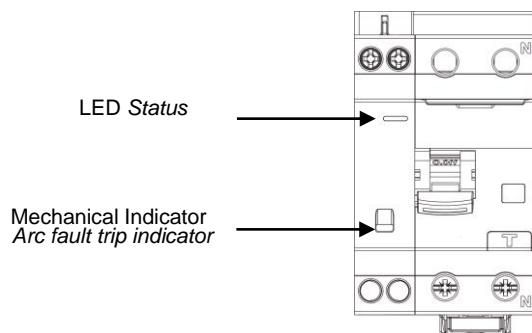



Arc fault device status display:

- By both indicator light and mechanical indicator



4. POSITIONING - CONNECTION (continued)

Indicator meaning code

Indicators state	meaning
 + 	No or incorrect electrical source or/and device switched off
 + 	Normal running: The circuit is monitored and protected by the arc fault device
 + 	Arc fault detected: The device tripped to avoid the risk of fire Installation has to be verified
 + 	Abnormal running: The circuit is not protected by the arc default device.

Insulation tests:

- Very important:
- Disconnect output wires and handle must be OFF.

Arc fault detection tests:

- The DX³ STOP ARC is equipped with an auto-test function running continuously. The LED indicates if an abnormal running is detected.

Sealing:

- Possible in the open or closed positions

Labelling:

- Circuit identification by way of a label inserted in the label holder situated on the front of the product.



Phase + Neutral, neutral on right side

5. GENERAL CHARACTERISTICS

Neutral earthing system:

. IT, TT, TN

Marking on the front side:

. By permanent ink pad printing

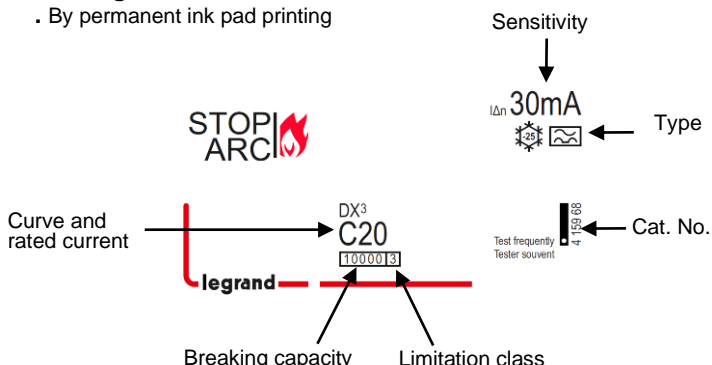

Marking on the upper panel:

. By permanent ink pad printing

Rated frequency

50Hz
230 V~

Rated voltage

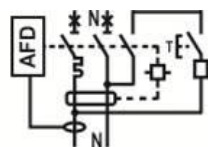

Electrical diagram

. The terminals upstream and downstream of the neutral pole are marked with an "N" moulded close to the screw heads.

Minimum operating voltage:

. U = 70 V (without auxiliaries)
. U = 95 V (with auxiliaries)

Maximum operating voltage:

. U = 250 V

Test operating voltages:

I Δ n	30 mA
min. U	180 V~
max. U	264 V~

Breaking capacity:

. With a single-phase network (with alternating current 50 Hz)

Standard	Breaking capacity	Voltage between poles	Breaking capacity
EN/IEC 61009-1	I _{cs}	230 V	7.5 kA
	I _{cn}		10 kA

Residual breaking capacity:

. In accordance with standard EN/IEC 61009-1 section 9.12.11.4d (I Δ m: short-circuit to earth) I Δ m = 4.5 kA

5. GENERAL CHARACTERISTICS (continued)

Isolation distance:

. The distance between the contacts is greater than 5.5 mm with the handle in the open position.
. The RCBO is suitable for isolation in accordance with standard EN/IEC 61009-1.

Insulation voltage:

. U_i = 400 V in accordance with standard EN/IEC 61009-1

Degree of pollution:

. 2 in accordance with standard EN/IEC 61009-1.

Dielectric strength:

. 2,000 V

Rated impulse withstand voltage

. U_{imp} = 4 kV

Degree or class of protection:

. Terminals protected against direct contact, class of protection against solid objects and liquids (wired device): IP20 in accordance with standards IEC 529 / EN 60529 and NF 20-010
. Front side protected against direct contact: IP40
. Class II in relation to metallic conductive parts
. Class of protection against mechanical impacts IK02 in accordance with standard EN 62262.

Plastic materials:

. Polyamide and P.B.T.

Enclosure heat and fire resistance:

. Resistance to glow wire tests at 960°C, in accordance with standard EN/IEC 61009-1
. Classification V2, in accordance with standard UL94

Higher heating potential:

. The heat potential is assessed at: 3.4MJ

Closing and opening force via the handle:

. 5 N on opening
. 14 N on closing

Mechanical endurance:

. Compliant with standard EN/IEC 61009-1 & EN/IEC 62606
. Tested with 20,000 operations with no load

Electrical endurance:

. Compliant with standard EN/IEC 61009-1 & EN/IEC 62606
. Tested with 10,000 operations with load (at I_n x Cos ϕ 0.9)

Sinusoidal vibration resistance (in accordance with IEC 68.2.6):

. Axes: x – y – z
. Frequency: 10 to 55 Hz
. Acceleration: 3g (1g = 9.81 m.s⁻²)

Resistance to tremors:

. In accordance with standard NF EN 61009-1

Ambient temperature:

. Operation: from - 25°C to + 40°C
. Storage: from - 25°C to + 70°C

Phase + Neutral, neutral on right side

5. GENERAL CHARACTERISTICS (continued)

EMC Compatibility:

The design of DX³ STOP ARC with its intelligent signal analysis of the power grid avoids any interference with PLC signal.

Tests according to IEC 61000 guarantee electromagnetic compatibility with other devices on the power grid.

Packaged volume:

Packaging	Volume (dm ³)
Per 1	0.52

Average unit weight per catalogue number:

. 0.3 kg

Derating of DX³ STOP ARC function of the number of devices placed side by side:

When several RCBOs are installed side by side and operate simultaneously, the heat dissipation of one pole is limited. This results in an increased operating temperature for RCBOs which may cause false tripping. Applying the following coefficients to the operating currents is recommended.

Number of DX ³ STOP ARC side by side	Coefficient
2 - 3	0.9
4 - 5	0.8
6 - 9	0.7
≥ 10	0.6

These values are provided by recommendation IEC 60439-1 and the standards NF C 63421 and EN 60439-1.

In order to avoid having to use these coefficients there must be good ventilation and the devices must be kept apart using the spacing elements Cat. No. 4 063 07 (0.5 module).

Derating of DX³ STOP ARC in the event of use with fluorescent tubes:

LEDs and electronic or ferromagnetic ballasts provide a high inrush current for a very short time. These currents are liable to cause tripping of the RCBOs.

The maximum number of ballasts per DX³ STOP ARC stated by the lamp and ballast manufacturers in their catalogues should be taken into account during installation.

Impact of height:

	≤ 2000 m	3,000 m	4,000 m	5,000 m
Dielectric strength	2,000 V	1,750 V	1,500 V	1,250 V
Maximum operating voltage	230 V	230 V	230 V	230 V
Derating at 30°C	none	none	none	none

Dissipated power (W):

. with In/Un

Rated current	6 A	10A	13 A	16 A	20 A
Power (W) dissipated	3.3	3.4	5.1	6.6	8.3

Phase + Neutral, neutral on right side

5. GENERAL CHARACTERISTICS *(continued)***Derating of DX³ STOP ARC depending on the ambient temperature:**

. The nominal characteristics of a circuit breaker are modified depending on the ambient temperature which prevails in the cabinet or enclosure where the DX³ STOP ARC is located.

. Reference temperature: 30°C in accordance with standard EN/IEC 61009-1.

In (A)	- 25 °C	- 10 °C	0 °C	10 °C	20 °C	30 °C	40 °C	50 °C	60 °C	70 °C
6	7.5	7.2	6.9	6.6	6.3	6	5.7	5.4	5.1	4.8
10	12.5	12	11.5	11	10.5	10	9.5	9	8.5	8
13	16.25	15.6	14.95	14.3	13.65	13	12.35	11.7	11.05	10.4
16	20	19.2	18.4	17.6	16.8	16	15.2	14.4	13.6	12.8
20	25	24	23	22	21	20	19	18	17	16

Specific use:

. Appropriate to operate in humid atmosphere and polluted by a chlorinated environment (pool-type)

Phase + Neutral, neutral on right side**6. COMPLIANCE AND APPROVALS****In accordance with standard:**

- . IEC/EN 61009-1
- . IEC/EN 62606

Usage in special conditions:

- . Category C compliant (testing temperature range from -25°C to +70°C, resistant to salt spray) in accordance with the classification defined in Appendix Q of standard IEC 60947-1

Respect for the environment – Compliance with European Union Directives:

- . Compliance with Directive 2002/95/EC of 27/01/03 known as "RoHS" which provides for a restriction on the use of dangerous substances such as lead, mercury, cadmium, hexavalent chromium and polybrominated biphenyl (PBB) and polybrominated diphenyl ether (PBDE) brominated flame retardants from 1st July 2006
- . Compliance with the Directive 91/338/EEC of 18/06/91 and decree 94-647 of 27/07/04

Plastic materials:

- . Halogen free plastic materials.
- . Labelling of parts compliant with ISO 11469 and ISO 1043.

Packaging:

- . Design and manufacture of packaging compliant with decree 98-638 of 20/07/98 and Directive 94/62/EC

Phase + Neutral, neutral on right side

7. CURVES

Arc tripping time curve

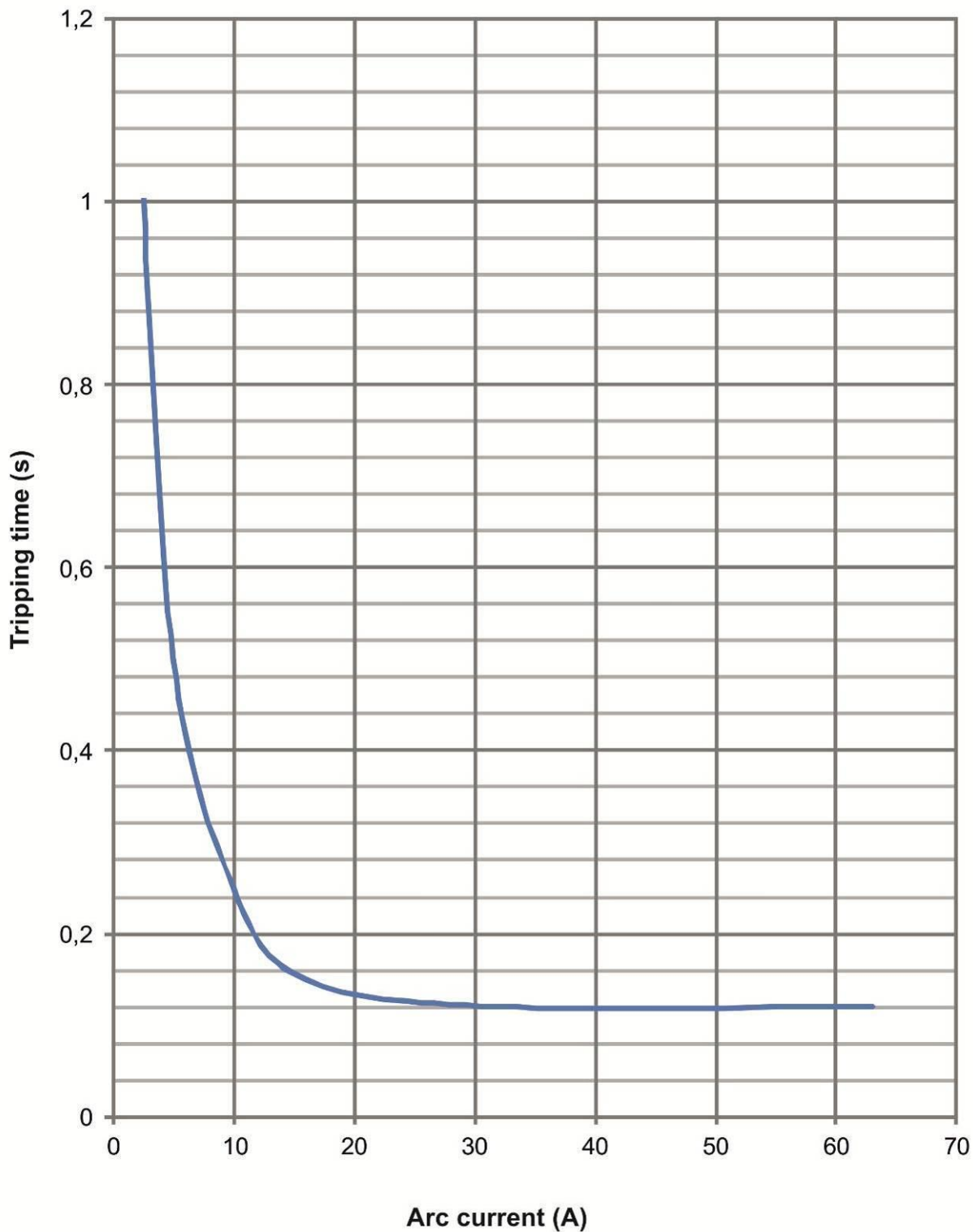

Phase + Neutral, neutral on right side

7. CURVES (continued)

Thermal-magnetic tripping range typical of C curve DX³ STOP ARC:

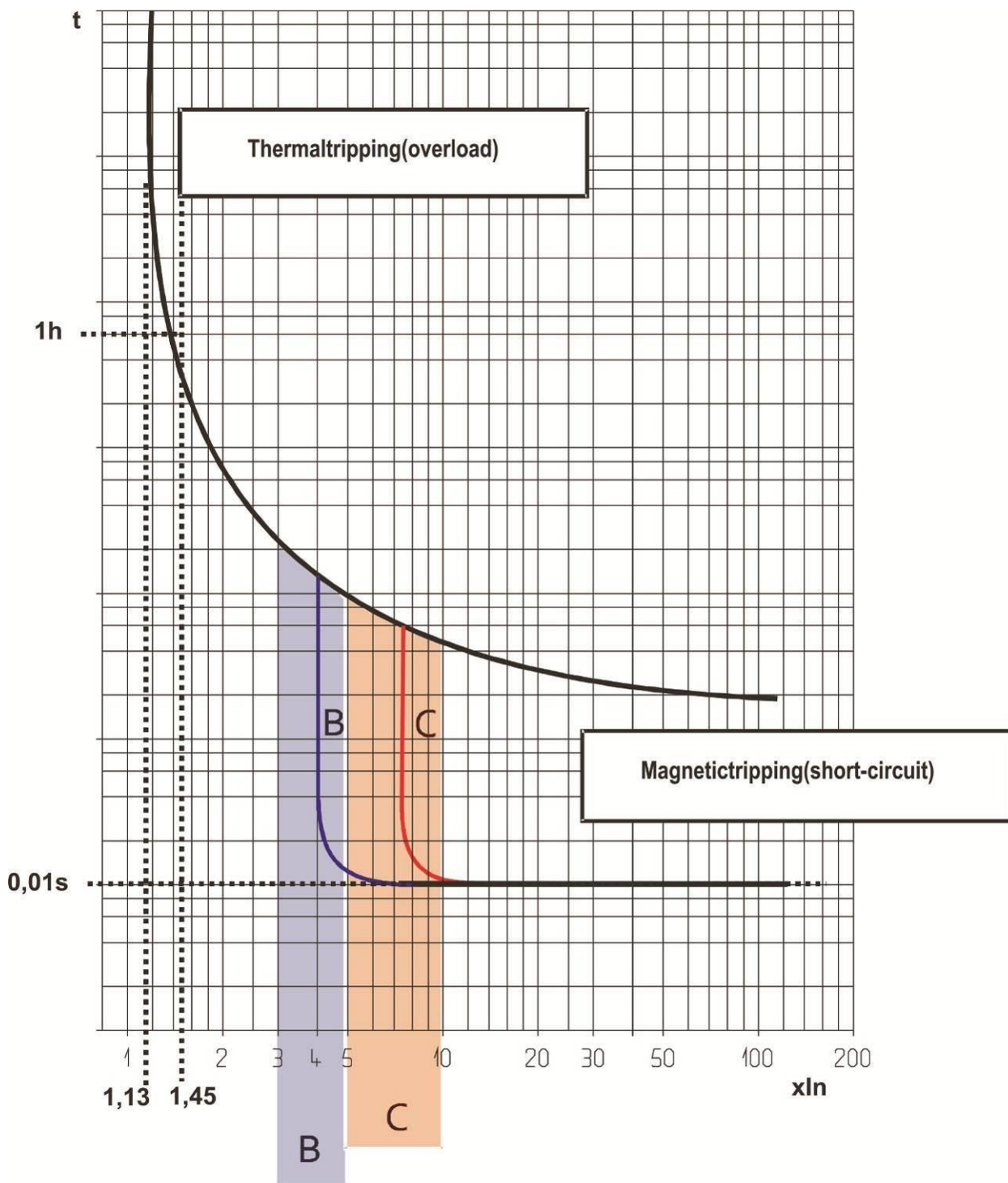

Thermal tripping at ambient temperature = 30°C
 In = DX³ STOP ARC rated current

Phase + Neutral, neutral on right side

7. CURVES (continued)

Average thermal-magnetic tripping curves range typical of B curve DX³ STOP ARC:

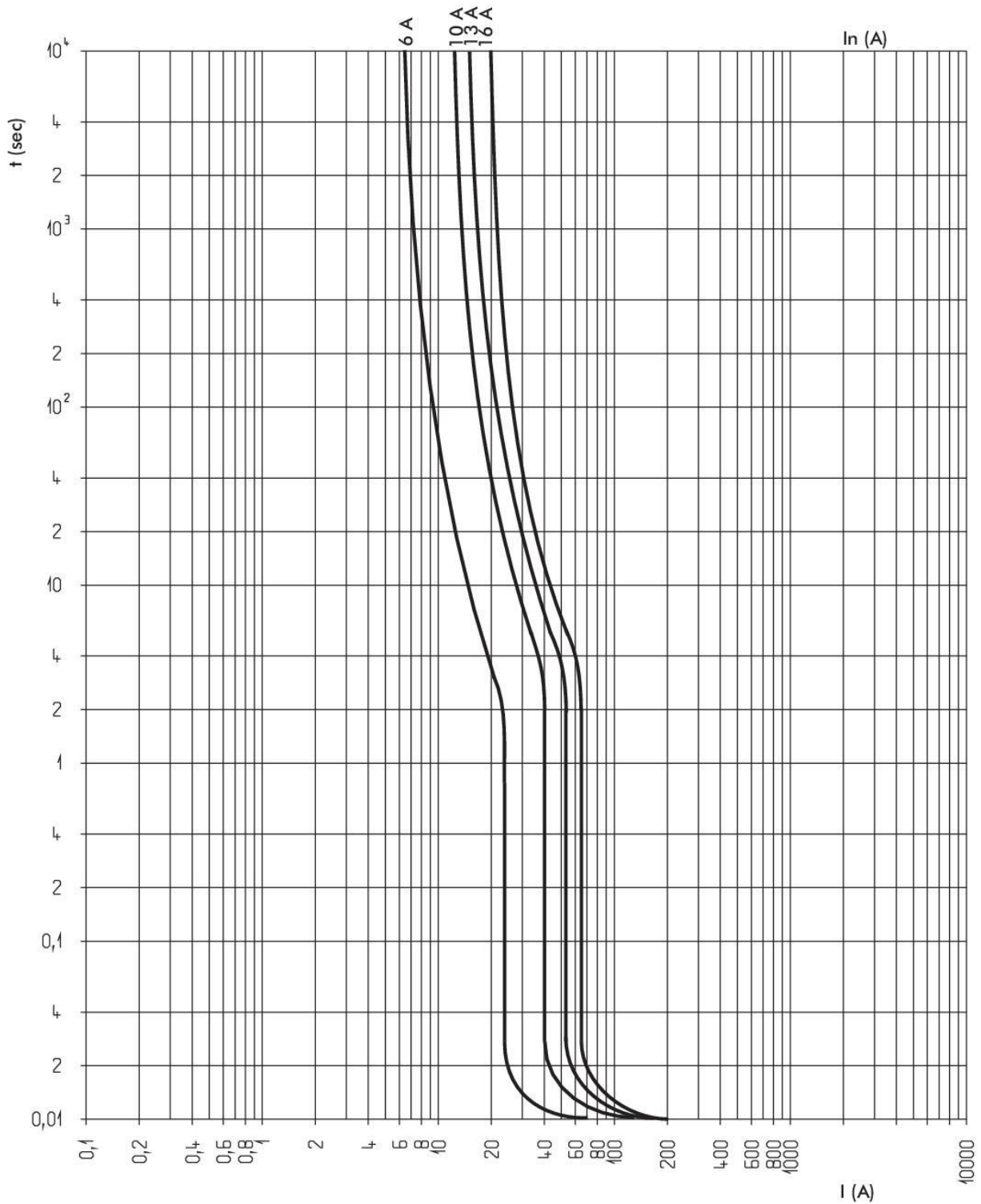

Phase + Neutral, neutral on right side

7. CURVES (continued)

Average thermal-magnetic tripping curves range typical of C curve DX³ STOP ARC:

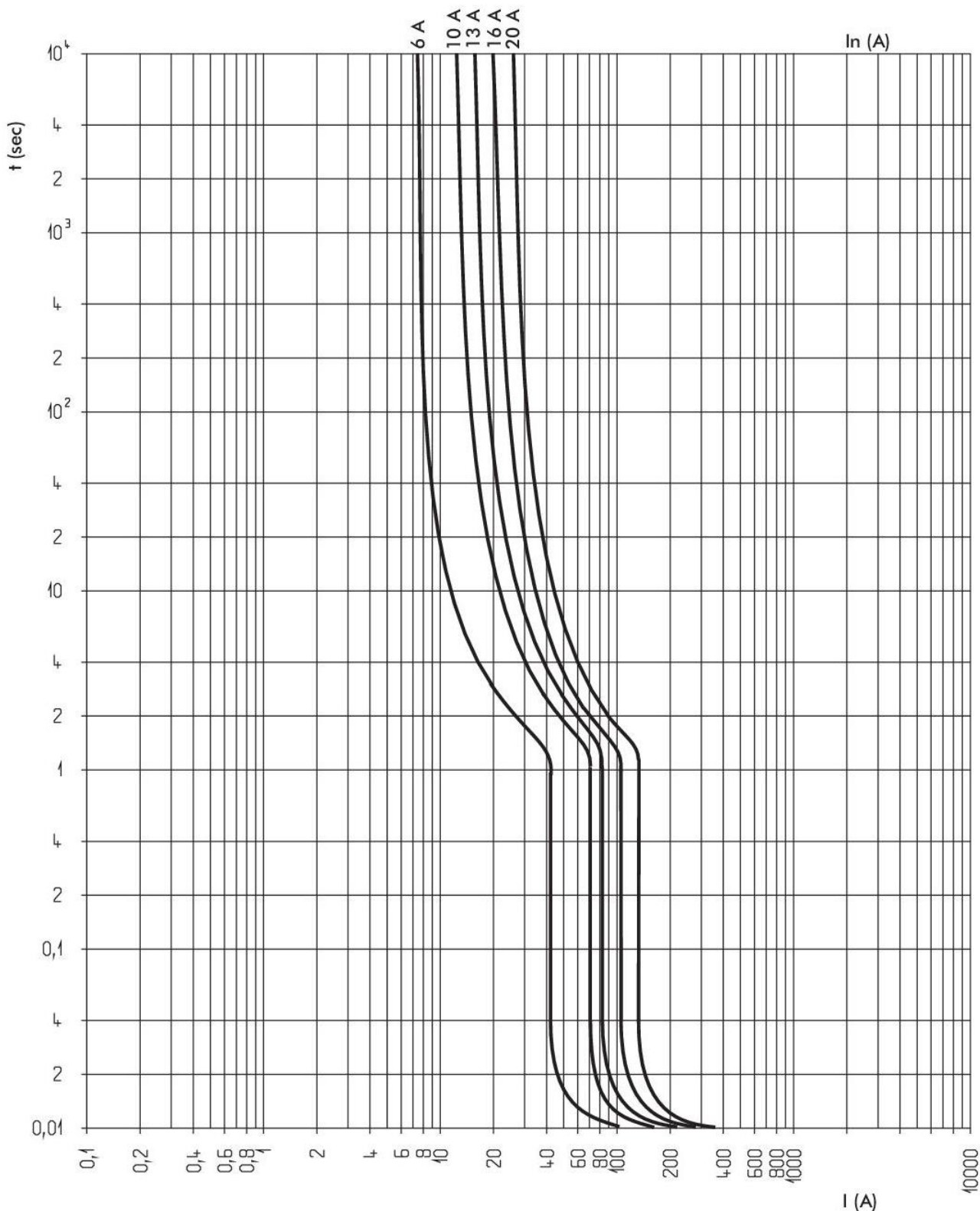

Phase + Neutral, neutral on right side

7. CURVES (continued)

Current limiting curves:

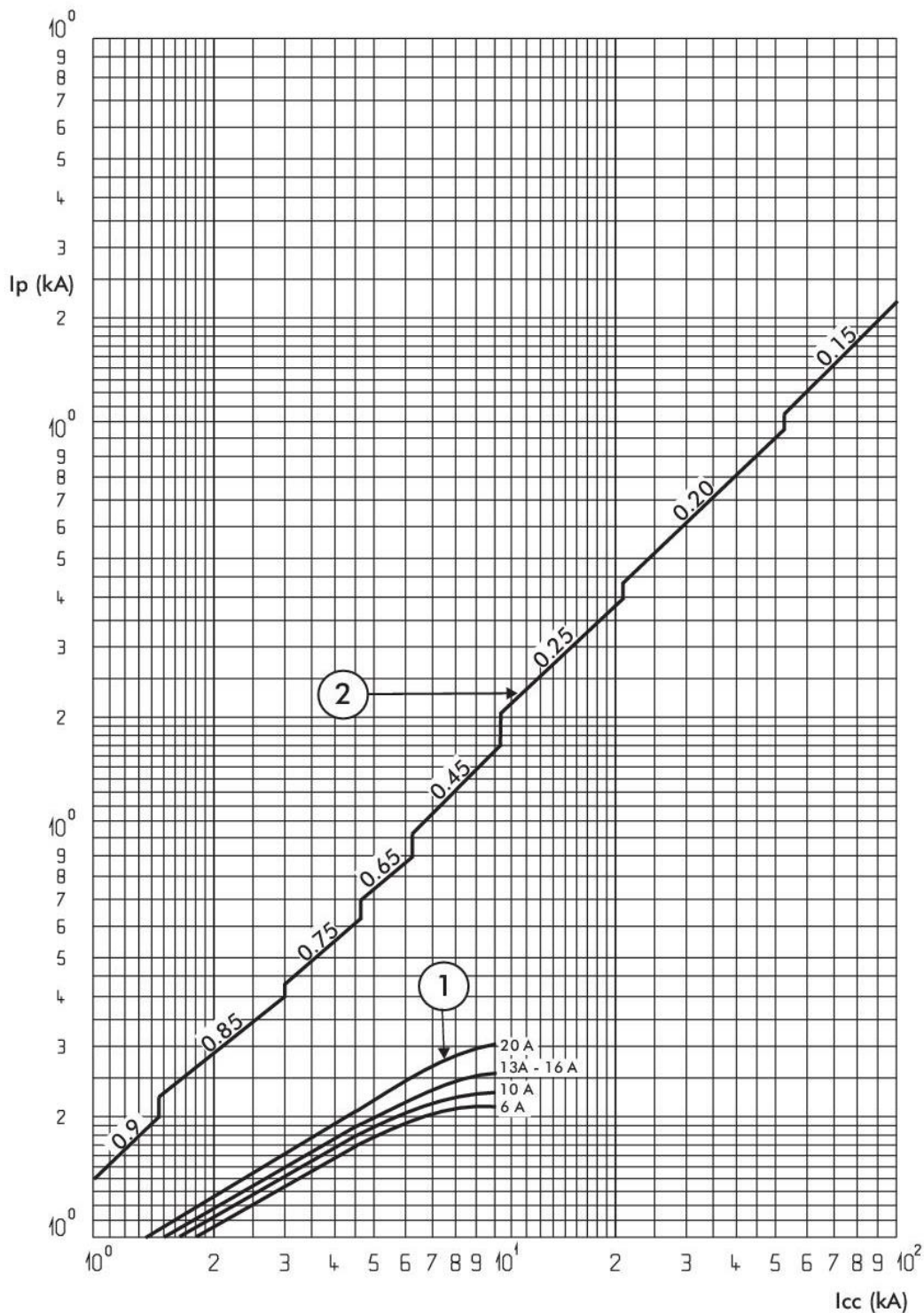

I_{cc} = Prospective short-circuit symmetrical current (rms value in kA)

I_p = Maximum peak value (in kA)

1 = Short-circuit rms currents (max. peak)

2 = Unlimited peak currents (max.), corresponding to power factors shown above (0.15 to 0.9)

Phase + Neutral, neutral on right side

7. CURVES (continued)

Thermal stress limiting curves:

. C curve RCBOs (230V/50Hz)

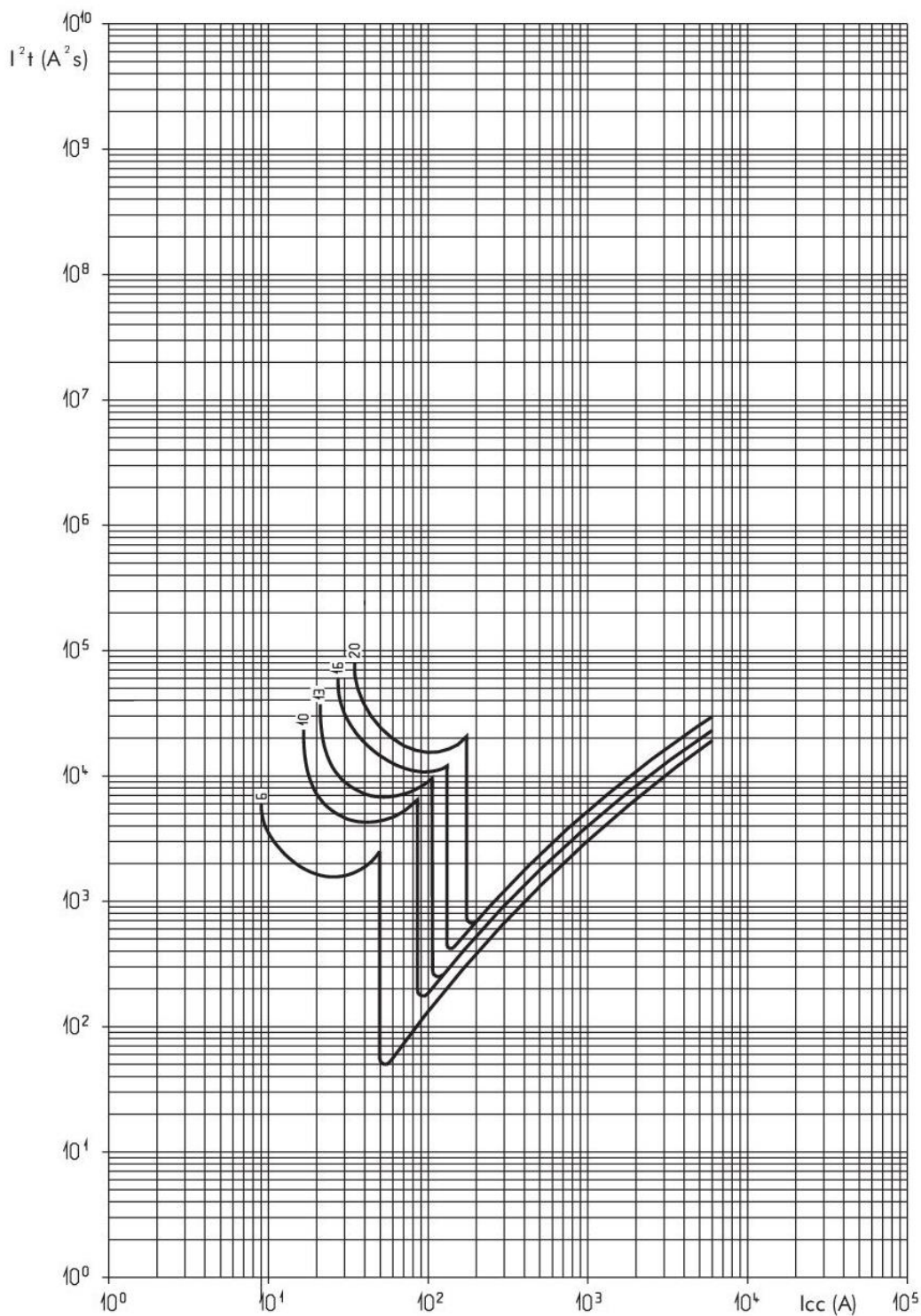

I_{cc} = Prospective short-circuit symmetrical current (rms value in A)
 I^2t = Limited thermal stress (in $A s^2$)

Phase + Neutral, neutral on right side

7. CURVES *(continued)*

Tripping current curves:

. Tripping time curve depending on the value of the residual current:

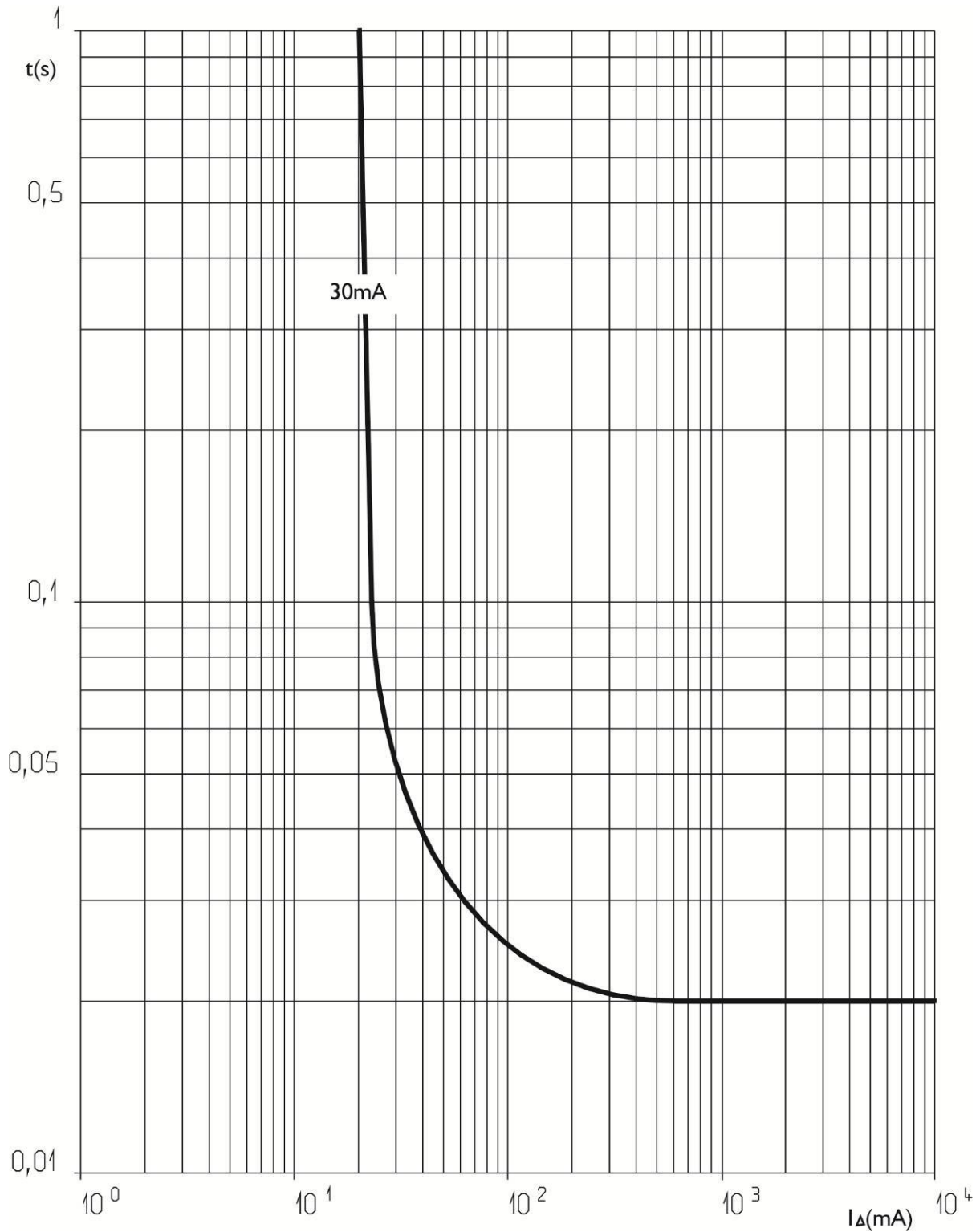

Phase + Neutral, neutral on right side**8. AUXILIARIES AND ACCESSORIES****Wiring accessories:**

- . Sealable screw cover (Cat. No. 4 063 04)

Signalling auxiliaries:

- . Auxiliary contact (0.5 module, Cat. No. 4 062 50)
- . Fault signalling contact (0.5 module, Cat. No. 4 062 52)
- . Auxiliary contact that can be changed into fault signalling contact (0.5 module, Cat. No. 4 062 56)
- . Auxiliary contact + fault signalling contact that can be changed into 2 auxiliary contacts (1 module, Cat. No. 4 062 64)

Control auxiliaries:**Only possible with a signalling auxiliary positioned between the control auxiliary and the DX³ STOP ARC**

- . Shunt trip (1 module, Cat. No. 4 062 76 / 78)
- . Under voltage release (1 module, Cat. No. 4 062 80 / 82)
- . Autonomous shunt trip release for N/C push-button (1.5 module, Cat. No. 4 062 87)
- . Power Overvoltage Protection (1 module, Cat. No. 4 062 86)

Possible combinations of auxiliaries and the DX³ STOP ARC:

- . The auxiliaries are installed to the left of the DX³ STOP ARC
- . Maximum number of auxiliaries = 2
- . Maximum number of 1 module signalling auxiliaries = 1

Locking options:

- . Via padlock 5 mm in diameter (Cat. No. 4 063 13) or padlock 6 mm in diameter (Cat. No. 0 227 97) and padlock support (Cat. No. 4 063 03)

Installation software:

- . XL PRO³

9. SAFETY:

For your safety your electrical installation is equipped with residual current protection which must be tested periodically.

In the absence of any national regulations on the time period required for this, Legrand recommends that this test be carried out every month: press the "T" test button, the device should trip. Please call an electrician immediately if this does not happen as the safety level of your installation has been reduced.

The presence of residual current protection does not remove the need to observe all the precautions associated with using electrical energy.