

Type 3 surge protection device - PLT-SEC-T3-24-FM-UT - 2907916

Please be informed that the data shown in this PDF Document is generated from our Online Catalog. Please find the complete data in the user's documentation. Our General Terms of Use for Downloads are valid (<http://phoenixcontact.com/download>)



Type 3 surge protection, consisting of protective plug and base element, with integrated status indicator and remote signaling for single-phase power supply networks. Nominal voltage 24 V AC/DC.

Your advantages

- ✓ Increased service life and availability of the system, thanks to optimal protection of your industrial power supply
- ✓ 5-year warranty on your QUINT 4 power supply when installed together with PLT-SEC, see document in the download area
- ✓ Easy maintenance and testing of protective devices, thanks to pluggable connections



Key Commercial Data

Packing unit	5 pc
GTIN	 4 0 5 5 6 2 6 2 5 7 4 1 9
GTIN	4055626257419

Technical data

Dimensions

Height	93.4 mm
Width	17.7 mm
Depth	74.5 mm (incl. DIN rail 7.5 mm)
Horizontal pitch	1 Div.

Ambient conditions

Degree of protection	IP20
Ambient temperature (operation)	-40 °C ... 80 °C
Ambient temperature (storage/transport)	-40 °C ... 80 °C
Altitude	≤ 2000 m (operating voltage remote contact ≤ 250 V) ≤ 6000 m (operating voltage remote contact ≤ 150 V)
Permissible humidity (operation)	5 % ... 95 %
Shock (operation)	30g (Half-sine / 11 ms / 3x ±X, ±Y, ±Z)

Type 3 surge protection device - PLT-SEC-T3-24-FM-UT - 2907916

Technical data

Ambient conditions

Vibration (operation)	5g (5 ... 500 Hz / 2.5 h / X, Y, Z)
-----------------------	-------------------------------------

General

EN type	T3
IEC power supply system	TN-S
Number of ports	One
Mode of protection	L-N
	L-PE
	N-PE
Mounting type	DIN rail: 35 mm
Color	light grey RAL 7035
	traffic grey A RAL 7042
Housing material	PA 6.6-FR 20% GF
	PA 6.6-FR
Degree of pollution	2
Flammability rating according to UL 94	V-0
Type	DIN rail module, two-section, divisible
Number of positions	2
Surge protection fault message	Optical, remote indicator contact

Protective circuit

Nominal frequency f_N	50 Hz (60 Hz)
Maximum continuous voltage U_C	34 V AC
Rated load current I_L	26 A (at 30 °C)
Residual current I_{PE}	$\leq 5 \mu\text{A}$
Nominal discharge current I_n (8/20) μs	1 kA
Standby power consumption P_C	$\leq 2.7 \text{ mVA}$ (at U_{REF})
	$\leq 4.8 \text{ mVA}$ (at U_C)
Reference test voltage U_{REF}	27 V AC
Combination wave U_{OC}	2 kV
Voltage protection level U_p (L-N)	$\leq 0.2 \text{ kV}$
Voltage protection level U_p (L-PE)	$\leq 0.6 \text{ kV}$
Voltage protection level U_p (N-PE)	$\leq 0.6 \text{ kV}$
TOV behavior at U_T (L-N)	50 V AC (120 min / withstand mode)
TOV behavior at U_T (L-PE)	50 V AC (120 min / withstand mode)
Response time t_A (L-N)	$\leq 25 \text{ ns}$
Response time t_A (L-PE)	$\leq 100 \text{ ns}$
Response time t_A (N-PE)	$\leq 100 \text{ ns}$
Short-circuit current rating I_{SCCR}	10 kA AC
Max. backup fuse with branch wiring	32 A (gG / B / C)
Maximum backup fuse for through wiring	25 A (gG / B / C)

Type 3 surge protection device - PLT-SEC-T3-24-FM-UT - 2907916

Technical data

Additional technical data

Short-circuit current rating I_{SCCR}	0.25 kA DC (without additional backup fuse)
	5 kA DC (for 20 A gG / B backup fuse)
Maximum discharge current I_{max} (8/20) μ s	4 kA
Nominal discharge current I_n (8/20) μ s	3 kA
Maximum continuous voltage U_c	44 V DC
Mode of protection	(DC+) - (DC-)
	(DC+/DC-) - PE

Indicator/remote signaling

Switching function	PDT contact
Operating voltage	250 V AC
	125 V DC (200 mA DC)
Operating current	0.5 A AC
	0.5 A DC (75 V DC)
Connection method	Screw connection
Conductor cross section flexible	0.2 mm ² ... 2.5 mm ²
Conductor cross section solid	0.2 mm ² ... 2.5 mm ²
Conductor cross section AWG	30 ... 12
Screw thread	M3
Tightening torque	0.5 Nm
Stripping length	10 mm

Connection data

Connection method	Screw connection
Conductor cross section flexible	0.2 mm ² ... 2.5 mm ²
Conductor cross section solid	0.2 mm ² ... 4 mm ²
Conductor cross section AWG	24 ... 12
Screw thread	M3
Tightening torque	0.5 Nm
Stripping length	10 mm

UL specifications

SPD Type	4CA
Maximum continuous operating voltage MCOV	34 V AC
	34 V DC
Nominal voltage	34 V DC
Rated load current I_L	20 A
Mode of protection	L-N
	L-G
	N-G
	(DC+) - (DC-)
	(DC+) - G

Type 3 surge protection device - PLT-SEC-T3-24-FM-UT - 2907916

Technical data

UL specifications

	(DC-) - G
Power distribution system	Single phase
	DC
Measured limiting voltage MLV (L-N)	200 V
Measured limiting voltage MLV (L-G)	510 V
Measured limiting voltage MLV (N-G)	510 V
Nominal discharge current I _n	1 kA

UL indicator/remote signaling

Operating voltage	250 V AC (0.5 A)
	12 V DC (4 A)
	24 V DC (2 A)
	48 V DC (1 A)
Tightening torque	5 lb _f -in. ... 7 lb _f -in.
Conductor cross section AWG	30 ... 12

UL connection data

Conductor cross section AWG	16 ... 12
Tightening torque	4.4 lb _f -in.

Standards and Regulations

Standards/specifications	IEC 61643-11 2011
	EN 61643-11 2012

Environmental Product Compliance

REACH SVHC	Lead 7439-92-1
China RoHS	Environmentally Friendly Use Period = 50
	For details about hazardous substances go to tab "Downloads", Category "Manufacturer's declaration"

Drawings

Type 3 surge protection device - PLT-SEC-T3-24-FM-UT - 2907916

Product drawing



Type 3 surge protection device - PLT-SEC-T3-24-FM-UT - 2907916

Diagram

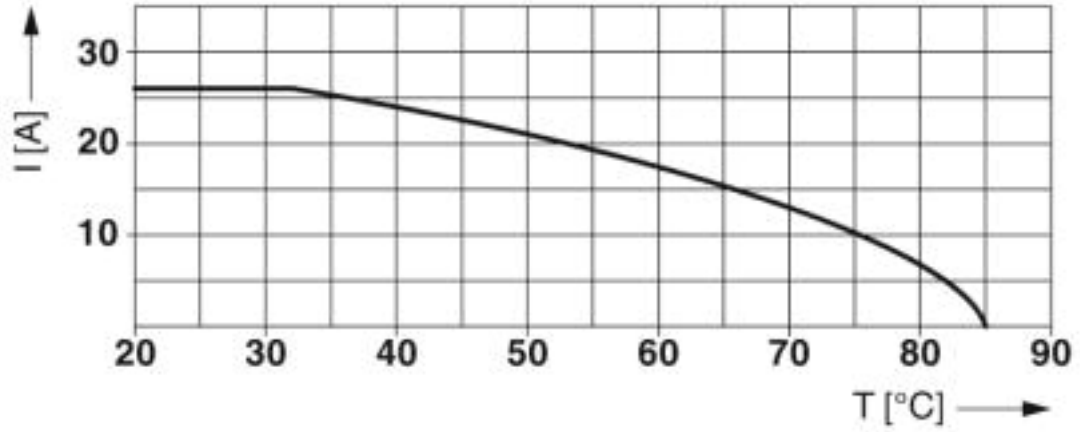

Nominal current depending on ambient temperature

Dimensional drawing

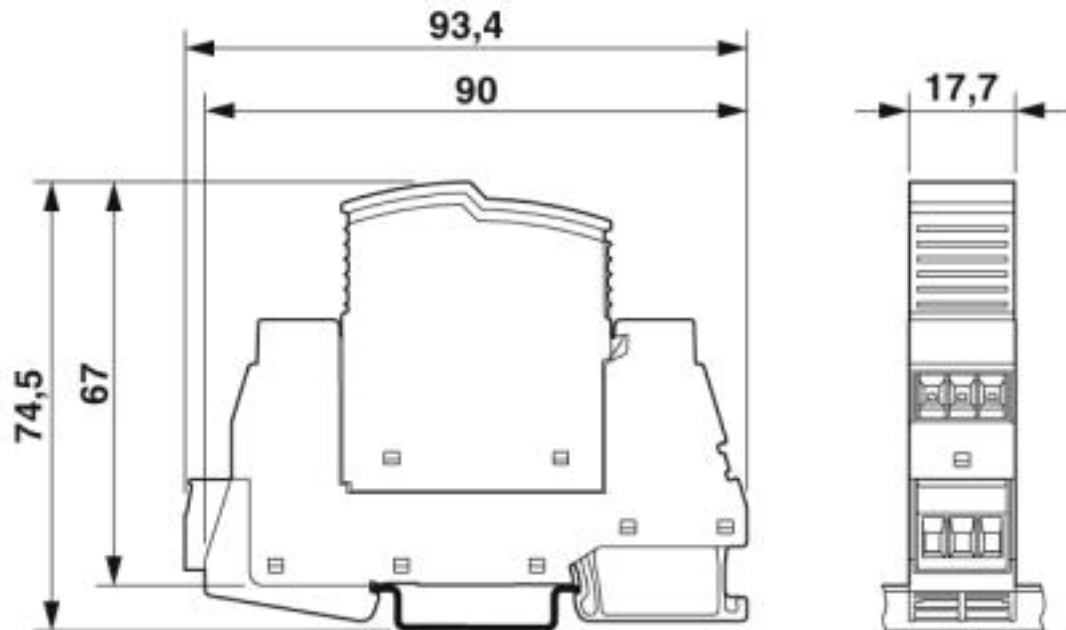

Type 3 surge protection device - PLT-SEC-T3-24-FM-UT - 2907916

Circuit diagram

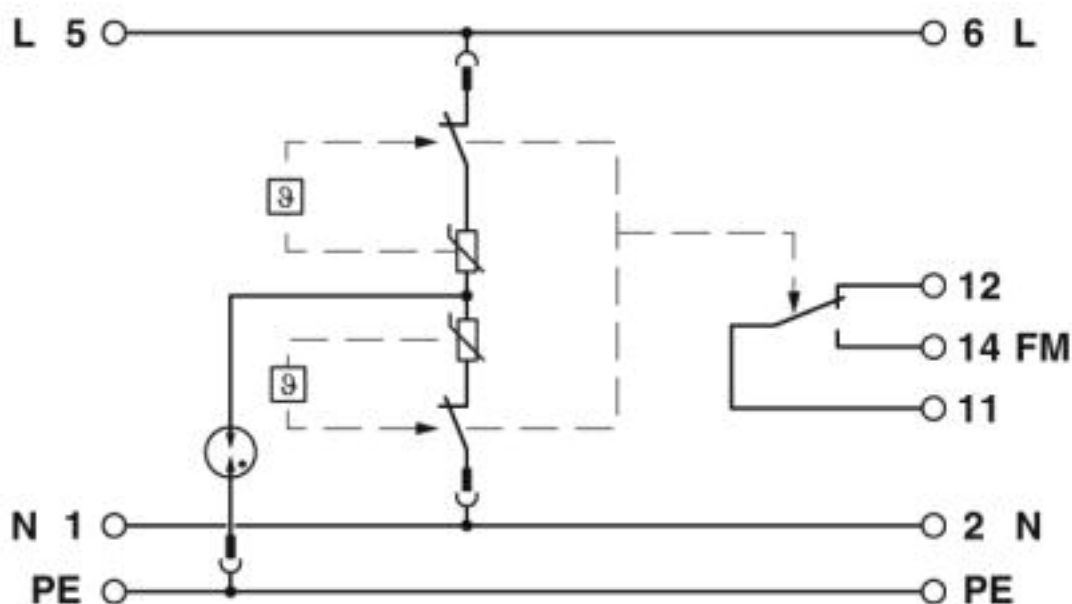

Approvals

Approvals

Approvals

DNV GL / CCA / UL Recognized / KEMA-KEUR / cUL Recognized / IEC CB Scheme / EAC / cULus Recognized

Ex Approvals

UL Recognized / cUL Recognized / cULus Recognized

Approval details

DNV GL		https://approvalfinder.dnvgl.com/	TAE00002U7
--------	--	---	------------





CCA			NTR-NL 7676
-----	--	--	-------------

UL Recognized		http://database.ul.com/cgi-bin/XYV/template/LISEXT/1FRAME/index.htm	FILE E 330181
---------------	--	---	---------------

KEMA-KEUR		http://www.dekra-certification.com	71-103027
-----------	--	---	-----------

Type 3 surge protection device - PLT-SEC-T3-24-FM-UT - 2907916

Approvals

cUL Recognized		http://database.ul.com/cgi-bin/XYV/template/LISEXT/1FRAME/index.htm	FILE E 330181
IECEE CB Scheme		http://www.iecee.org/	NL-51083
EAC			RU C- DE.A*30.B01561
cULus Recognized			

Phoenix Contact 2019 © - all rights reserved
<http://www.phoenixcontact.com>

PHOENIX CONTACT GmbH & Co. KG
Flachsmarktstr. 8
32825 Blomberg
Germany
Tel. +49 5235 300
Fax +49 5235 3 41200
<http://www.phoenixcontact.com>