

Leuchtmelder, 22 mm, rund, Metall, hochglanz, klar, Linse, glatt



Produkt-Markename	SIRIUS ACT
Produkt-Bezeichnung	Leuchtmelder
Ausführung des Produkts	Betätigungs-/Meldeelement
Produkttyp-Bezeichnung	3SU1

Betätigungselement

Farbe	
<ul style="list-style-type: none"> des Betätigungselements 	klar
Material des Betätigungselements	Kunststoff
Form des Betätigungselements	rund
Außendurchmesser des Betätigungselements	29,45 mm

Frontring

Produktbestandteil Frontring	Nein
------------------------------	------

Allgemeine technische Daten

Schutzart IP	IP66, IP67, IP69(IP69K)
Schutzart NEMA	NEMA 1, 2, 3, 3R, 4, 4X, 12, 13
Schockfestigkeit	
<ul style="list-style-type: none"> gemäß IEC 60068-2-27 	Sinushalbwelle 50g / 11 ms
Referenzkennzeichen gemäß IEC 81346-2:2009	P

Referenzkennzeichen gemäß DIN EN 61346-2	P
--	---

Anschlüsse/Klemmen

Anzugsdrehmoment der Schrauben im Halter	1 ... 1,2 N·m
--	---------------





Umgebungsbedingungen

Umgebungstemperatur	
• während Betrieb	-25 ... +70 °C
• während Lagerung	-40 ... +80 °C
Umweltkategorie während Betrieb gemäß IEC 60721	3M6, 3S2, 3B2, 3C3, 3K6 (bei relativer Luftfeuchtigkeit von 10 ... 95 %)

Einbau/ Befestigung/ Abmessungen

Höhe	29,5 mm
Breite	29,5 mm
Form der Einbauöffnung	rund
Einbaudurchmesser	22,3 mm
positive Toleranz des Einbaudurchmessers	0,4 mm
Einbauhöhe	11,8 mm
Einbaubreite	29,5 mm
Einbautiefe	24,4 mm

Approbationen/Zertifikate

allgemeine Produktzulassung	Konformitätserklärung	Prüfbescheinigungen
 CSA  UL  EAC  EG-Konf.	Sonstige	Typprüfbescheinigung/Werkszeugnis

Marine / Schiffbau

 ABS	 LRS	 PRS	 RINA	 RMRS	 DNV-GL DNVGL.COM/AF
---	---	---	--	--	--

Sonstige

Bestätigungen

Weitere Informationen

Information- and Downloadcenter (Kataloge, Broschüren,...) http://www.siemens.de/industrial-controls/catalogs
--

Industry Mall (Online-Bestellsystem)

<https://mall.industry.siemens.com/mall/de/de/Catalog/product?mlfb=3SU1051-6AA70-0AA0>

CAX-Online-Generator

<http://support.automation.siemens.com/WW/CAXorder/default.aspx?lang=de&mlfb=3SU1051-6AA70-0AA0>

Service&Support (Handbücher, Betriebsanleitungen, Zertifikate, Kennlinien, FAQs,...)

<https://support.industry.siemens.com/cs/ww/de/ps/3SU1051-6AA70-0AA0>

Bilddatenbank (Produktfotos, 2D-Maßzeichnungen, 3D-Modelle, Geräteschaltpläne, EPLAN Makros, ...)

http://www.automation.siemens.com/bilddb/cax_de.aspx?mlfb=3SU1051-6AA70-0AA0&lang=de

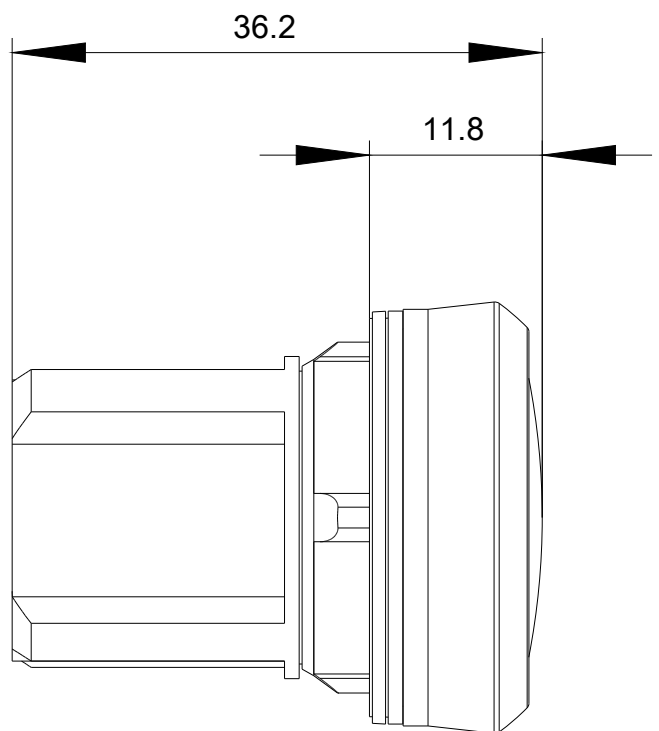
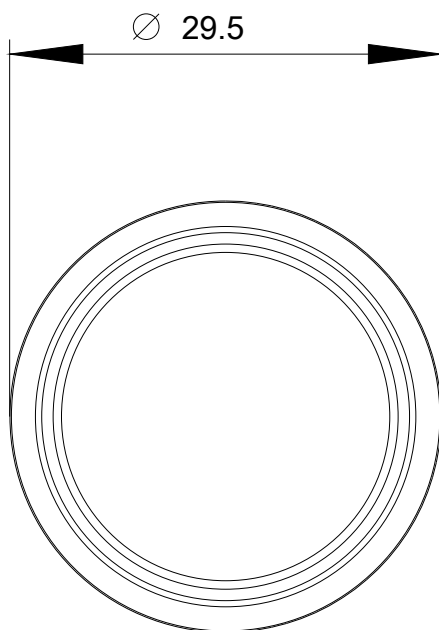

letzte Änderung:

05.06.2019