

3-Phasen-Einspeiseklemme für 3-Phasen-Sammelschiene Anschluss von oben Baugröße S00/S0

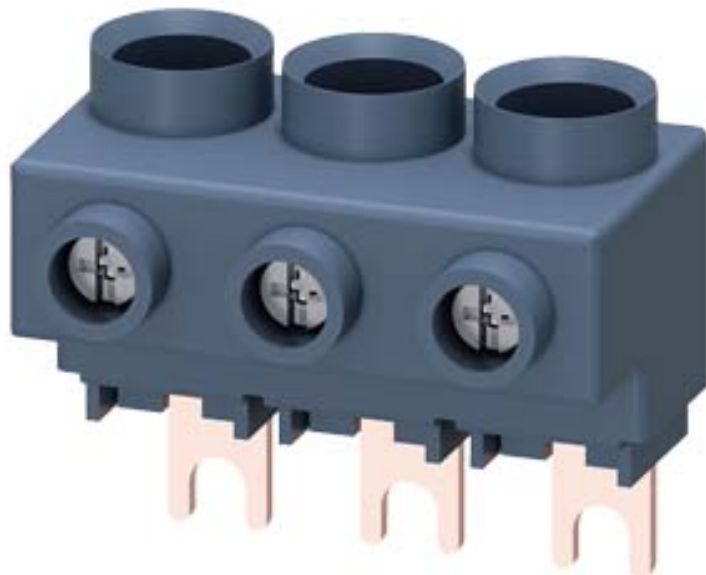

Allgemeine technische Daten:

Produkt-Markename		SIRIUS
Produkt-Bezeichnung		3-Phasen Einspeiseklemme
Ausführung des Produkts		von oben, Baugröße S0/S00
Baugröße des Leistungsschalters		S00, S0
Schutzart IP frontseitig		IP20
Isolationsspannung bei Verschmutzungsgrad 3 Bemessungswert	V	690
Umgebungstemperatur		
• während Lagerung	°C	-50 ... +80
• während Betrieb	°C	-20 ... +60
Strombelastbarkeit maximal	A	63





Einbau/ Befestigung/ Abmessungen:





Breite	mm	44,5
Höhe	mm	39
Tiefe	mm	27,2



Anschlüsse/ Klemmen:

Ausführung des elektrischen Anschlusses für Hauptstromkreis		Schraubanschluss
Art der anschließbaren Leiterquerschnitte		
<ul style="list-style-type: none"> • für Hauptkontakte <ul style="list-style-type: none"> — eindrätig — mehrdrätig — feindrätig <ul style="list-style-type: none"> — mit Aderendbearbeitung • bei AWG-Leitungen für Hauptkontakte 		1x (2,5 ... 16 mm ²) 1x (2,5 ... 25 mm ²) 1x (2,5 ... 16 mm ²) 1x (10 ... 4)

Approbationen/ Zertifikate:

Eignungsnachweis	CE / UL / CSA / CCC			
allgemeine Produktzulassung	Konformitätserklärung		Prüfbescheinigungen	
 CSA	 UL	 EAC	 EG-Konf.	Sonstige Typprüfbescheinigung/Werkzeugnis

Prüfbescheinigungen	Schiffbau				
spezielle Prüfbescheinigungen	 ABS	 BUREAU VERITAS	 LRS	 PRS	 RINA

Schiffbau	sonstiges	Railway
 RMRS	Bestätigungen  VDE	Schwingen / Schocken

Weitere Informationen

- Information- and Downloadcenter (Kataloge, Broschüren,...)**
<http://www.siemens.de/industrial-controls/catalogs>
- Industry Mall (Online-Bestellsystem)**
<http://www.siemens.com/industrymall>
- CAX-Online-Generator**
<http://support.automation.siemens.com/WW/CAXorder/default.aspx?lang=de&mlfb=3RV2925-5AB>
- Service&Support (Handbücher, Betriebsanleitungen, Zertifikate, Kennlinien, FAQs,...)**
<https://support.industry.siemens.com/cs/ww/de/ps/3RV2925-5AB>
- Bilddatenbank (Produktfotos, 2D-Maßzeichnungen, 3D-Modelle, Geräteschaltpläne, EPLAN Makros, ...)**
http://www.automation.siemens.com/bilddb/cax_de.aspx?mlfb=3RV2925-5AB&lang=de

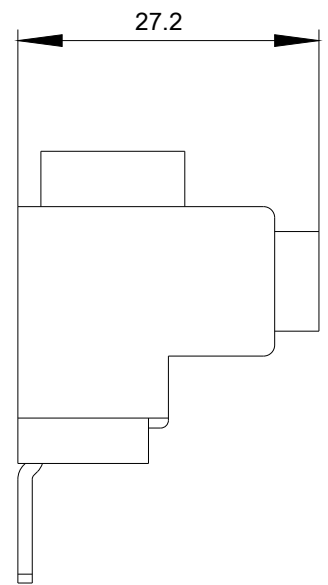
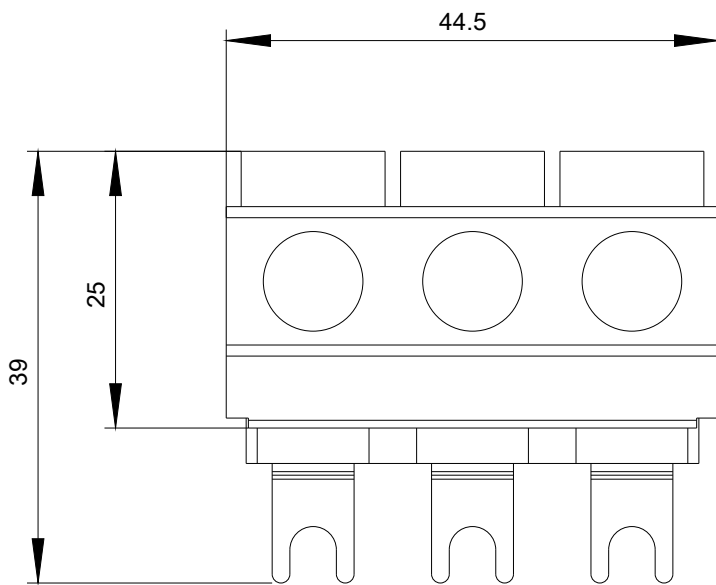

letzte Änderung:

18.02.2019